

Smoothy – Continuous Cord Loop Cellular Shade Installation Instructions

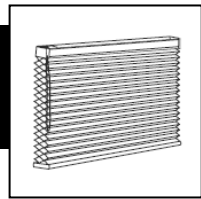

BASICS

A few simple tools are required:

- Measuring Tape
- Power drill, drill bits
- Phillips driver bit
- Pencil



Standard Mounting Bracket



Optional Extension Bracket



Optional 3/8" Spacer Block



Optional Hold Down Bracket

Additional fasteners other than those sent with your shade may be required depending on the mounting surface. Wallboard and plaster require the use of anchors such as expansion or toggle bolts. Brick, tile or stone need special plugs and drill bits. Remember to always pre-drill holes in wood to avoid splitting. Contact your local hardware store for fasteners specific to your application. Please do not remove the sticker from the headrail. It provides important information that is helpful for future repairs and proof of warranty.

BRACKET INSTALLATION

Shades are shipped with the required number of brackets for proper installation. Brackets should be located approximately 3" from either end. Depending on the width of the shade, additional brackets may be necessary, evenly space additional brackets between the two end brackets.

Using the Installation Bracket as a template, measure 3" in from the end of the shade and mark the hole locations with a pencil for drilling. When mounting brackets, make sure they are in line and level.

Brackets must be in line and level.

The headrail must be level for the shade to operate properly.

For shade widths:	# of brackets:
Up to 40"	2
40" – 72"	3
72" – 84"	4
84" and up	5
Inside Mount	1 screw/bracket
Outside Mount	2 screws/bracket



Inside or Ceiling Mounts

Use the top bracket holes. Requires 1 screw.

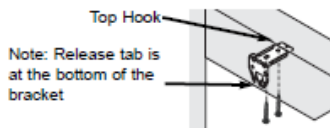

Wall or Outside Mounts

Use the rear bracket holes. Requires 2 screws.

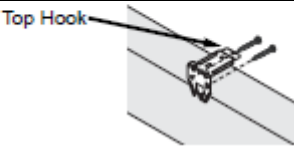

Hold Down Bracket (optional)

Hold Down brackets are provided upon Request to prevent shades swinging when mounted on doors. Hold Down Brackets are mounted with the supplied screws. With the shade at its proper drop, place the pin of each Hold Down into the hole in each End Cap and mark the screw holes. Make sure the pins are level and aligned. Raise the shade and then screw the Hold Down Bracket into the mounting surface. Hold Down Brackets are designed for Outside Mounted Shades only.

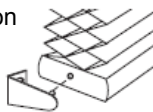

Outside Mount with Spacer Block (optional)

Optional spacer block will project bracket 3/8".

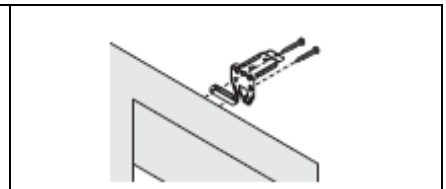

Outside Mount with Extension Bracket (optional)

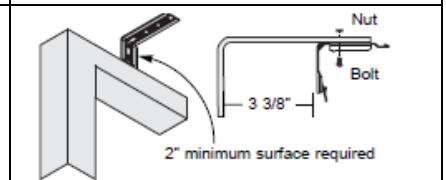

Side Mount with Extension Bracket (optional)

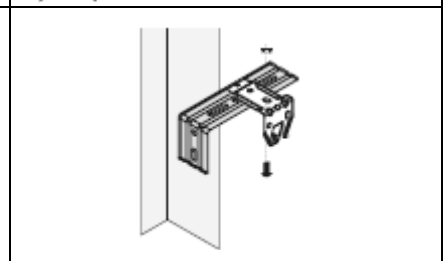

INSERTING THE HEADRAIL

First, lower the bottom rail about an inch. This will help keep the fabric from getting caught between the brackets and the headrail.

Position the headrail with the front lip (A) resting on the top hooks of all the brackets. Make sure that no fabric is pinched between the brackets and the headrail.

Push the bottom of the headrail firmly upwards and toward the window until the groove at the bottom of the headrail snaps into place, (B) as shown.

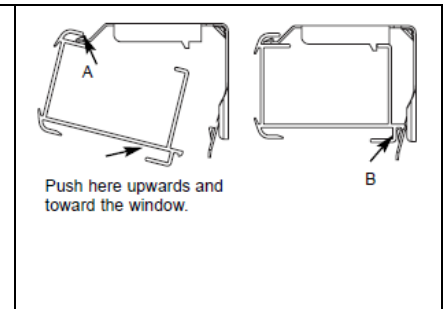

REMOVING THE HEADRAIL

To remove a shade, insert a screwdriver between the headrail and the bottom back of the bracket (tab which extends out lightly from each bracket).

Gently pry the screwdriver to release the bracket from the headrail. Take care not to damage the painted finish of the headrail or the fabric. As you release the shade from the brackets, hold the headrail to keep it from falling.

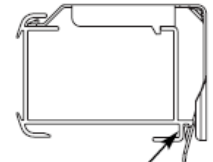

Insert screwdriver here and gently pry.

CHILD SAFETY – WARNING

PROTECT YOUR CHILDREN & PETS



Be aware that it is possible for children to strangle in window covering cords. To reduce the occurrence of accident, all cords must be kept out of the reach of children, including infants.

Cord cleats and tensioning devices are an effective way to implement this essential precaution. A cord tension device with mounting instructions is included with each cord loop shade.

No safety system is fail-safe. KEEP CORDS OUT OF REACH OF SMALL CHILDREN!

INSTALL TENSION DEVICE

The tension device reduces the hazards of strangulation and entanglement of young children by limiting access to the control cord.

The tension device should be installed without stretching or pulling down on the control cord. Stretching the cord will cause excessive wear.

Do not twist or cross the control cord.

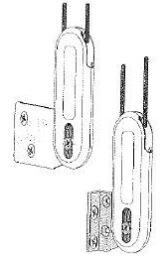

SHADE OPERATION

Operate the shade by pulling down on one side of the cord. – The front cord raises the shade; the rear cord lowers the shade. Do not lift the bottom rail with your hands. Also, be careful not to place objects on the window sill that will interfere with operating the shade or cause it to hang unevenly. **Double Cell Black Out fabric tends to hold air**, so raise slowly to allow shade to stack fully at the top. If a shade is unlevel, level the bottom of the shade before operating. See Equalization note below.

TROUBLE SHOOTING

Problem: The shade will not stay down.

Cause: Because the shade was fabricated primarily in the closed position, the fabric may want to spring up.

Repair: For a light filtering shade, with clean hands, gently pull down on a section of cells to relax the pleats. Repeat with another section of cells until the fabric is sufficiently relaxed. For a black out shade, avoid wrinkling the front of the fabric by grabbing shade at the sides and stretching downward. Do not fully raise the shade for 24 hours.

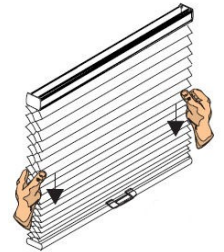

Problem: Fabric billows out when shade is raised.

Cause: Fabric can relax when stretched out for extended periods of time.

Repair: Raise the shade *very* slowly to allow the retraction mechanism to overcome the force of the stretched fabric.

CLEANING AND CARE

Our cellular shades are designed for durability as well as easy care and cleaning. Our fabrics repel dust and are inherently anti-static, but occasional feather dusting or vacuuming with a brush attachment may help to keep the fabrics clean and bright. Spills and stains can be lightly blotted with a cloth or damp sponge.

If you have a **light filtering shade**, you may need to rub gently with water and clear mild liquid soap (no bleach!). To clean an entire light filtering shade, simply remove the shade from the window and submerge it in a tub, let it soak and then rub it gently with clear mild liquid soap. Lay the shade flat to dry or place it back in the window and raise it slightly.

****BLACK OUT FABRIC CANNOT BE SUBMERGED! SPOT CLEAN ONLY.****

CELLULAR SHADE LEVELING – EZEQ

Cellular shades use a system that allows easy leveling of the bottom rail.

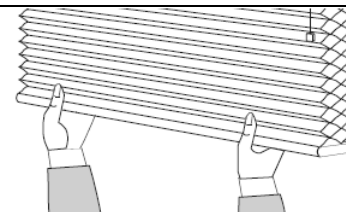

Stand in the center of the shade and grasp the bottom rail with both hands.

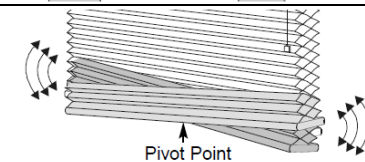

Position the rail as desired, by pulling down on the side that is too high.

NOTE: SHADES PURCHASED WITH THE SIDE TRACK SYSTEM

Please refer to the companion side track installation instructions that are provided with your side track shades. Side tracks are optional.